



# **HATHORN**

---

## **INSPECTION CAMERAS**



## **OPERATOR'S MANUAL FOR H12+ CONTROLLER**

**For Safe and Effective Operation:**

Before operation of your system, it is advised  
that this manual be read carefully.

# **CONTENTS**

<b>PAGE 3</b>	<b>LIMITED WARRANTY</b>
<b>PAGE 4</b>	<b>LIMITATION OF WARRANTY/ SERVICE/ FREIGHT</b>
<b>PAGE 5-6</b>	<b>GENERAL SAFETY &amp; CARE INFORMATION</b>
<b>PAGE 7</b>	<b>PRODUCT SPECIFICATIONS</b>
<b>PAGE 8-10</b>	<b>KEYPAD &amp; MENU ICONS</b>
<b>PAGE 11-12</b>	<b>KEYBOARD FUNCTIONS &amp; USER INSTRUCTIONS</b>
<b>PAGE 13</b>	<b>WI-FI INSTRUCTIONS*</b>
<b>PAGE 14</b>	<b>RECORDING VIDEO / SCREENSHOTS</b>
<b>PAGE 15</b>	<b>PLAYING / RENAMING / DELETING FILES</b>
<b>PAGE 16</b>	<b>INSPECTION PROCEDURE</b>
<b>PAGE 17-18</b>	<b>LOCATING THE SONDE</b>
<b>PAGE 19-20</b>	<b>TROUBLESHOOTING &amp; MAINTENANCE</b>
<b>PAGE 21-22</b>	<b>REPAIR FACILITIES IN USA &amp; CANADA</b>

\*For Wi-Fi Versions only

## **LIMITED WARRANTY**

This Limited Warranty provides one full year of coverage under our manufacturer's standard new product warranty. Hathorn® Corporation warrants to the original purchaser of our products that the product shall function as designed for a period of one year from the original date of purchase under normal and proper usage. This one year Limited Warranty covers malfunctions resulting from defects in materials or workmanship only. If the product fails to function as designed under normal and proper usage due to defects in materials or workmanship during the period of this Limited Warranty, we will repair, adjust or replace defective parts as Hathorn® Corporation deems appropriate.

This Limited Warranty applies only to Hathorn® Corporation sewer and gas camera systems that are distributed in the United States, Canada and Australia that are purchased from Hathorn® Corporation or a Hathorn® Corporation authorized dealer as identified on our website. The Limited Warranty is not transferable under any circumstances. This Limited Warranty does not apply to Hathorn® Corporation brand products imported and/or sold by unauthorized dealers, distributors, or other sellers.

## **NOT COVERED BY WARRANTY**

This one year Limited Warranty does not cover damage or malfunctions stemming from other than normal and proper usage or from products not meeting the requirements of end users. This Limited Warranty also does not cover the following: (a) intentional or accidental misuse or abuse (including, but not limited to, damage to push rod from excessive force), (b) failure to follow operating or maintenance instructions, (c) repairs by any individual or entity other than an authorized Hathorn® Corporation repair center, (d) use of product components, accessories or consumables not manufactured by Hathorn® Corporation (e) product tampering, (f) droppage, (g) battery leakage if equipped, (h) media cards, (i) excessive light damage to the camera element or (j) damage resulting from being used in extreme environments or due to weather events. Wear and tear are not covered.

Hathorn®'s responsibility under this Limited Warranty is limited to the repair, adjustment or replacement of defective parts as determined by Hathorn® Corporation in its sole discretion. Hathorn® Corporation shall not be held liable for any damages, including, but not limited to direct, indirect, special, or consequential damages arising out of, resulting from, or in any way connected to the use of Hathorn® products. Hathorn® assumes no responsibility for other's use or misuse of its products. Hathorn® Corporation assumes no responsibility for warranties either expressed or implied.

## **LIMITATION OF LIABILITY**

By purchasing a Hathorn® Corporation product, you accept the terms of this limited warranty. You also agree that Hathorn® Corporation shall have no liability to you or any end user for any damages resulting from delay or loss of use of the product due to failure of the product within the warranty period, or otherwise, or in service or repair. Hathorn® shall have no liability for general, special, incidental, or consequential damages arising out of the use or misuse of Hathorn® products.

You also agree that the application and use of a Hathorn® Corporation product is beyond our control and is the sole responsibility of the user. By receiving and using one of Hathorn®'s products, you hereby acknowledge and agree that: you have selected the correct product for your intended use and will examine the product you are purchasing when it arrives to ensure that it meets your needs, you will properly test the product prior to its actual use, you and/or your organization have proper practices in place for the safe use of this equipment and that end users have been trained on its safe operation.

Hathorn® products are not intrinsically safe, not explosion proof, and misuse of the product may cause physical or psychological injury, pain, suffering, illness, disfigurement, temporary or permanent disability, economic or emotional loss or death; and Hathorn® Corporation shall not be held liable for any damages, including but not limited to direct, indirect, special, or consequential damages arising out of, resulting from, or in any way connected to the improper or incorrect use of the product and assumes no responsibility for other's use of the product.

## **SERVICE**

If the product requires service, please contact the Hathorn® service centre, or one of our authorized repair centers. Some service locations are listed in this document (Pages 18 & 19). The remainder can be found on our website.

After requesting a Return Merchandise Authorization (RMA), ship the item PREPAID and INSURED to the appropriate service center. Hathorn® is not responsible for damages or loss incurred in connection with mailing and/or transportation of products.

## **RETURN FREIGHT**

**Warranty:** Pre-Paid by customer as above, returned by Hathorn® on our account.

**Non-Warranty:** Freight paid by customer both directions.

## **NON-WARRANTY CHARGES**

Repairs centers will charge direct for non-warranty repairs and may require payment prior to repair.

# **GENERAL SAFETY & CARE INFORMATION**

## **HEALTH AND SAFETY**

This equipment is primarily used for inspecting sewer pipes by professionals operating in the sewer and plumbing industry and maintained by professionals familiar with the health risks of maintaining equipment in a sewer. Such professionals should be protected by their company's recommendations and work practices.

Always be aware of your surroundings and keep all electrical connections dry and off the ground. Do not work near open pits or traffic. Hathorn recommends that users wear personal protection such as eyewear, rubber gloves, and non-skid safety shoes.

## **WORKSITE SAFETY**

Use your company's or other applicable safety codes and rules when using this equipment. Do not use this equipment in any area with the presence of flammable liquids, gases, and heavy dust. Hathorn's inspection cameras are not explosion proof nor are they intrinsically safe.

## **EQUIPMENT SAFETY AND DURABILITY**

- Do not open the enclosures (housings) of the control module or camera heads. Opening the housings, control module, or camera head will void any warranty.
- Use only the leads supplied with the control module for AC or DC operation.
- Hathorn tools accept only Milwaukee® M18 18V batteries or equivalent. Batteries must be removed from the equipment when not in operation. Failure to do so can result in damage to your camera or the battery.
- Do not use pressure washers to clean the reel or other camera system parts. Pressure washing any part of your Hathorn camera will cause internal damage which is not covered by your warranty.
- Do not soak the spring termination parts or the camera heads in bleach or other chemicals.
- This product is not designed for and should not be used to inspect oil or other petrochemical pipes.

## **FCC, ACMA AND IC STATEMENT**

Please note that changes or modifications not expressly approved by the party responsible for compliance could void the user's authority to operate the equipment. This device complies with Part 15 of the FCC Rules. Operation is subject to the following two conditions: (1) This device may not cause harmful interference, and (2) This device must

accept any interference received, including interference that may cause undesired operation.



If your device is Wi-Fi enabled and labeled as such, it will contain transmitter module: FCC ID: 2BKA8-SF1534A / IC: 32904-SF1534A / ACMA: RCMC161227















This device complies with Industry Canada license exempt RSS standard(s). Operation is subject to the following two conditions: (1) This device may not cause interference, and (2) This device must accept any interference, including interference that may cause undesired operation of the device.

Le présent appareil est conforme aux CNR d'Industrie Canada applicables aux appareils radioexempts de licence. L'exploitation est autorisée aux deux conditions suivantes: (1) l'appareil ne doit pas produire de brouillage, et (2) l'utilisateur de l'appareil doit accepter tout brouillage radioélectrique subi, même si le brouillage est susceptible d'en compromettre le fonctionnement.



# PRODUCT SPECIFICATIONS

<b>Weight without Battery</b>	9.5lbs (4.3Kg)
<b>Length x Width x Depth</b>	15" x 12" x 5.5" (38cm x 30cm x 14cm)
<b>Power</b>	
AC/DC Adapter	12V - 4.1A
Battery	Only Milwaukee® M18 18V or equivalent
Battery Life	~4hrs using 3.0Ah (not recording & sonde off)
Battery Extender	Yes with on-screen battery display
<b>Display</b>	
Type	Impact-resistant LCD
Size	12" (30.4cm)
Resolution	XGA 1024 x 768 pixels
Brightness	1,300 cd/m2
Zoom	1X, 2X, 4X, 8X with digital pan feature
<b>Footage Counter</b>	Feet or Meters with reset function
<b>Sonde Frequencies</b>	High power 512Hz
<b>Keyboard</b>	Full-sized QWERTY with silicone cover
<b>Text Overlay</b>	8 pages - save, recall, hide, delete
<b>Information Bar</b>	74 characters over two lines
<b>Media</b>	
Video	MPEG4 (H.264)
Screenshot	JPEG
Audio	Integrated Microphone and speaker
Languages	English, Spanish, French
<b>Storage Options</b>	USB, HDD or USB & HDD
<b>Storage Remaining</b>	USB and HDD in Kb
<b>HDD</b>	128Gb SSD (512Gb SSD optional) allowing user >100 hours (400 hours) of video capture
<b>USB</b>	USB 2.0 up 32Gb formatted in FAT format allowing user >25 hours of video capture
<b>Environmental</b>	
Operating Temperature	-10°C to 50°C (14°F to 122°F)
Storage Temperature	-20°C to 60°C (-4°F to 140°F)

# KEYPAD ICONS

		<b>Power On/Off</b>	
<b>Camera LEDs Up</b>			<b>Sonde On/Off</b>
<b>Camera LEDs Down</b>			<b>Footage Counter Reset</b>
<b>Hathorn Info Bar</b>			<b>Mic/Speaker On/Off</b>
<b>Zoom 1X, 2X, 4X, 8X</b>			<b>Menu Enter/Exit</b>
<b>Navigation Buttons</b>			<b>Enter/Confirm Selection</b>
<b>Stop Recording &amp; Playback</b>			<b>Pause Recording &amp; Playback Videos</b>
<b>Record Video</b>			<b>Take Screenshot</b>

# MAIN MENU OPTIONS

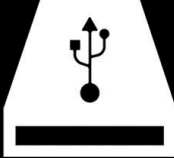
 <b>REEL SIZE OPTIONS</b>	 <b>CONTROLLER SETTINGS</b>	 <b>FILE STORAGE OPTIONS</b>
---	---	--



## INFORMATION BAR ICONS



Battery Monitor

Hathorn Inspection Cameras  
Information Bar

Info & Address Bar



Microphone

512Hz  
ON

Sonde On/Off Frequency



Recording Media

+0.0'

Footage (ft. or m)

11/22/2022  
2:35 pm

Date & Time

Zoom  
1x

Zoom

## SETTING UP YOUR MONITOR FOR FIRST USE

Your controller comes from the factory set for us using factory default settings. Should you wish to change any functions or options, press the MENU key, then select Controller Options.



In the Controller Options menu, you can change:

- Which Hathorn reel you want to use
- Monitor brightness and contrast. For optimal picture, leave brightness at 10 and contrast at 5
- Menu language (English, Spanish and French)
- Sonde frequency of 512Hz or 640Hz
- Footage measurement in Feet or Meters
- File recording location - HDD, USB, or both USB & HDD
- System Time & Date
- Battery extender On/Off, which automatically dims the screen when the battery is getting low
- Odometer - Note: This cannot be reset. Permanently records the footage that the monitor has recorded since new

**NOTE: YOU MUST SELECT THE CORRECT REEL  
AND PUSH ROD SIZE TO ENSURE CORRECT  
FOOTAGE COUNTER CALIBRATION.  
SEE PAGE 11.**

## KEYBOARD FUNCTIONS

The keyboard can be used to type information onto the screen overlay. Anything shown on the screen while recording will show up on the recording.

**Page 1 to Page 8** - Brings up the corresponding background page for typing in inspection details.

**Hide Page** - Hides the selected page. Please note that anything typed in will remain in the background until it is deleted or the system is restarted.

**Save Page** - Saves what is visible on the displayed screen into the page memory. Saving ensures your text will survive a system restart.

**Escape Key** - Functions the same as the MENU key on the keypad.

**Arrow Keys** - Moves cursor on text overlay and allows user to make menu selections.

**Return** - Functions as a line return key when typing. Doubles as the ENTER key within menus.

## INFORMATION BAR

The Hathorn INFO BAR allows the user to type in a company or client name for overlay onto videos and screenshots. Press the INFO BAR keypad button and use the keyboard to enter up to 74 characters of text. Text will remain until delete or system is shut down.



# USER INSTRUCTIONS

## Turning Your Monitor On

First, connect the patch cable to your reel and the controller.

Press the POWER button to turn on the controller. At this point, you should see the Hathorn logo on the screen while the system boots up. Boot up takes ~12 seconds.



**Note: It is good practice to remove batteries from electronic equipment after use. Failure to do so may result in the batteries being drained quicker over extended periods.**

## Entering the Main Menu

To bring up the Main Menu, press the MENU/HOME key on your controller.

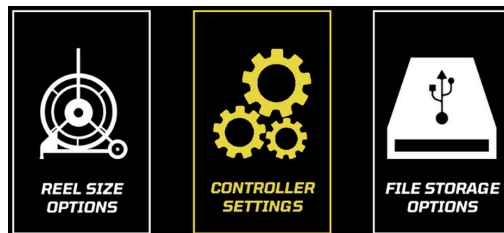

## Reel Selection

Your controller will work with all Hathorn reels, but you must select the correct reel size to ensure correct footage counter calibration. To select the correct reel, press the MENU button, then press enter on the REEL SIZE OPTIONS icon. You can then confirm which reel you are using. The controller will remember the last reel you selected on restart.

## Entering the Controller Options Menu

Highlight the CONTROLLER SETTINGS icon and press enter. The options menu will come up.

BRIGHTNESS	5
CONTRAST	5
LANGUAGE	 ENGLISH
SONDE SELECTION	512Hz
FOOTAGE COUNTER UNITS	FEET
STORAGE TYPE	USB & HDD
DATE/TIME SET	09:58 11/24/2022
BATTERY EXTENDER	ON
ODOMETER	525'

## Selecting a Menu Language

In the main menu, you can select the language you prefer to read menu information. Your choices are English, French, or Spanish. To select the preferred language, press the MENU button, then press enter again on the CONTROLLER SETTINGS icon. Press the enter key to highlight the language selection. Choose your language and press enter to confirm.

## Selecting a Sonde Frequency

In the main menu, you can select the frequency you wish to use - 512Hz or 640Hz. On the main screen, push the SONDE button to turn the sonde on or off. The Hathorn Info Bar will indicate which frequency is selected and if the sonde is active in green text.

## Turning the Sonde On /Off

On the main screen, push the SONDE button to turn the sonde on or off. Sondes are locatable up to ~15ft in depth, dependent upon the type of pipe (concrete/steel/cast iron) and the presence of thick concrete, sand, or other utilities.



## Footage Counter Reset

Pushing the COUNTER RESET button will reset the footage counter to zero.



## Camera Head LED Light Control

Camera head LED light brightness can be controlled using the LED UP/DOWN buttons on the front of the monitor. This feature may come in handy should you find yourself in brand new white pipes, glass pipes, or commercial food/pharmaceutical grade stainless steel pipework.



**NOTE: YOU MUST SELECT THE CORRECT REEL  
AND PUSH ROD SIZE TO ENSURE CORRECT  
FOOTAGE COUNTER CALIBRATION.  
SEE PAGE 11.**

# WI-FI USER INSTRUCTIONS\*

## Download the Wi-Fi App

- Turn on the mobile device and enter App Store for either Apple or Android
- Search for the Hathorn-V4 app ) latest version
- Install the app software
- Note: You must be running iOS 13 or later for Apple

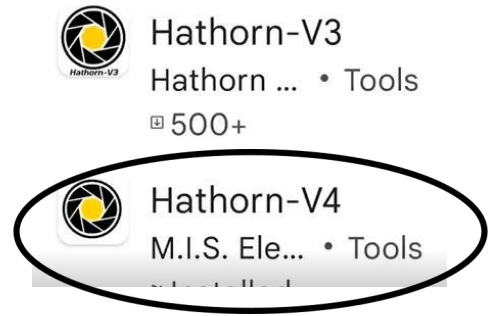

## Setting Up the System

Connect DC power plug to the jack on the reel hub using AC/DC adapter or 18V external battery. At this point, you should have lights on the camera.

Access Wi-Fi connections on your device and select the one named “Hathorn #####”. Enter password 12345678. Exit then open the “Hathorn” app and click “CONNECT”. At this point you should have video on your screen.

Note: That this network connection will block all data to the device until the connection is forgotten or another network selected.



- Back
- Record / Stop
- Screen Shot
- Photo Folder
- Change Screen Ratio

\*For Wi-Fi Versions only

## **WI-FI USER INSTRUCTIONS\***

### **VIDEO VIEWING AND RECORDING**

Open the app and click “CONNECT”. If the connection between the camera and the mobile device was successful, the video will begin playing automatically. If it does not, then repeat the Wi-Fi pairing steps. No option exists to pause during recording. If you wish to pause simply stop the recording and start a new one.

All pictures and videos are stored in the photos folder of your device.

**NOTE: YOU MUST ALLOW THE APP TO ACCESS TO YOUR PHOTOS FOLDER WHEN INSTALLING THE APP. IF YOU DO NOT THEN VIDEOS WILL NOT BE SAVED.**



\*For Wi-Fi Versions only

## RECORDING VIDEO

Select the media location you wish to record to in the Controller Setting Menu. You can choose USB, HDD, or both USB & HDD.

Insert the USB stick into the USB port if you wish to record to USB. All videos are stored in MPEG4 format.

Press the VIDEO RECORDING key on the control pad. You will be notified recording has begun and where files are being saved. Another note will appear in the INFO BAR.



For audio recording, press the MICROPHONE key on the keypad. Press again to mute. The green symbol means the mic is on, red means the mic is off.



To stop recording, press the STOP key. You will be notified that your file has been saved to media.



To access your recording, press the MENU key and toggle over to Media Options. Press enter and you will now have access to the HDD and USB media files.



*Note: a new file is created each day recordings/screen shots are made, and that file will have the date of the recordings as its name. All files will be saved in the appropriate dated folder.*

*Note: Files and folders are always created with the newest at the top. The most recent file saved will always be the first file in the first folder.*

## TAKING A SCREENSHOT

Follow the same instructions as above for video recording, but instead of pressing the VIDEO RECORDING key, press the SCREENSHOT key.

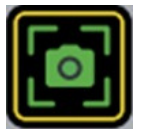

All screenshots are taken in JPEG format and capture whatever is on the screen when the picture is taken. To view photo files, follow the same instructions as above.

## PLAYING MEDIA FILES

Press the MENU key, then enter the FILE STORAGE OPTIONS menu.

Select the date on which files were recorded, then highlight the file you wish to play, and press the RIGHT ARROW or ENTER key on the keypad or enter key on the keyboard. Your selected file will now be playing (video) or be shown (screen shot). Volume of the playback of videos can be adjusted using the UP / DOWN keys.



The screenshot will be shown and the video will re-loop until you stop or exit. To exit, press the MENU key on the keypad or the escape key on the keyboard.

## FAST FORWARD / REWIND / PAUSE MEDIA PLAY

When playing a video file, use the LEFT and RIGHT arrow keys on the keypad to fast forward or rewind. Each jump will equal ~5% of the recorded video length.



Pressing the PLAY/PAUSE key on the keypad will allow the user to stop and start the recording for visual inspection.



## DELETING / RENAMING FILES

Highlight the file you wish to change and press the RIGHT ARROW key on the keypad. A menu will appear with several options.



You can now DELETE the file in question. Press the MENU key to return to the file.



## COPYING FILES TO / FROM USB & HDD

Highlight the file you wish to change and press the RIGHT ARROW key on the keypad. A menu will appear with several options.



You can now DELETE the file in question. Press the MENU key to return to the file.

## DELETING / RENAMING FOLDERS

Rather than deleting individual files at a time to free up space, the user can delete entire daily folders by highlighting the specific folder and pressing the STOP button. The user will be prompted to confirm deletion, and must press the ENTER key to confirm.



*Note: Remaining storage space (Kb) on the inserted USB is available at the top of the page while in this menu.*



## INSPECTION PROCEDURE

Skids or sleeves should ALWAYS be used to protect the camera head. Depending on the size of the pipe you are inspecting, you may need to use a skid, so the camera is centered or off the floor of the line. Care should be taken so the skids do not snag in the line.

Under normal operating situations, the camera is used with a smaller protective sleeve in lines under 4” in diameter, or a larger grooved skid in 4” lines or larger.

1. Slowly push the camera into the pipe and maneuver the camera into position to feed down the pipe, making sure the flex neck does not kink or double back on itself.
2. Push the camera slowly and carefully during the inspection, taking note of the conditions of the pipe for possible hazards that may entangle or damage the camera on entry or retrieval.
3. When maneuvering a corner, care should be taken not to butt the nose of the camera against the sidewall with any force. It would be better to let the camera “work” its way around the corner. If resistance is encountered when turning the corner and there are no visible signs of blockage, turning the push rod or pulling the camera back and forth sometimes helps.
4. Should resistance become extreme, or the camera gets entangled or stuck, slowly push it back and forth to free it. Sometimes, turning the push rod may also help. If the camera is visible, you may be able to free it with your hand or by some other means.
5. Upon completion of the inspection and retrieval of the camera, it may be necessary to ‘manipulate’ the camera around the initial bend (clean out) in the pipe with a pole or other device if required.
6. NEVER use the camera to unclog a drain or clear debris in the pipe. Doing so can cause damage to the camera head or lens.
7. NEVER force the camera down a pipe as this may cause a kinked cable, which will require expensive repairs.
8. NEVER use a pressure washer to clean any part of the system. High pressure water can cause degradation of the electronic parts, causing damage.
9. NEVER unspool all of the rod from a reel. Always leave a few turns of rod on the reel to aid with respooling.

## LOCATING THE SONDE SIGNAL (512HZ)

Insert the sonde into the drain and locate it while it is still just in view at the drain or duct entrance. Hold the locator vertically - directly over the sonde with the antenna in line with the sonde. Adjust the locator sensitivity so the bar graph reads between 60% and 80%. Push the sonde along the pipe to the desired area.

1. Approach the peak of the signal, working perpendicular to the pipe.  
Move the locator backwards and forwards and stop when the bar graph indicates a Peak.
2. Push the camera 4-6 ft. further, pinpoint, and mark the position. Repeat this pinpointing procedure at similar intervals along the line of the drain or duct until the survey is completed.
3. Most locators will automatically display the depth of a located sonde, provided the locator is correctly oriented and positioned above the sonde.

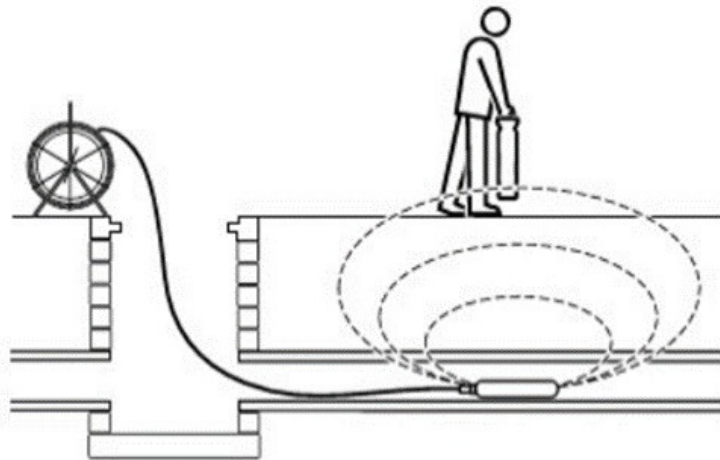

# TROUBLESHOOTING

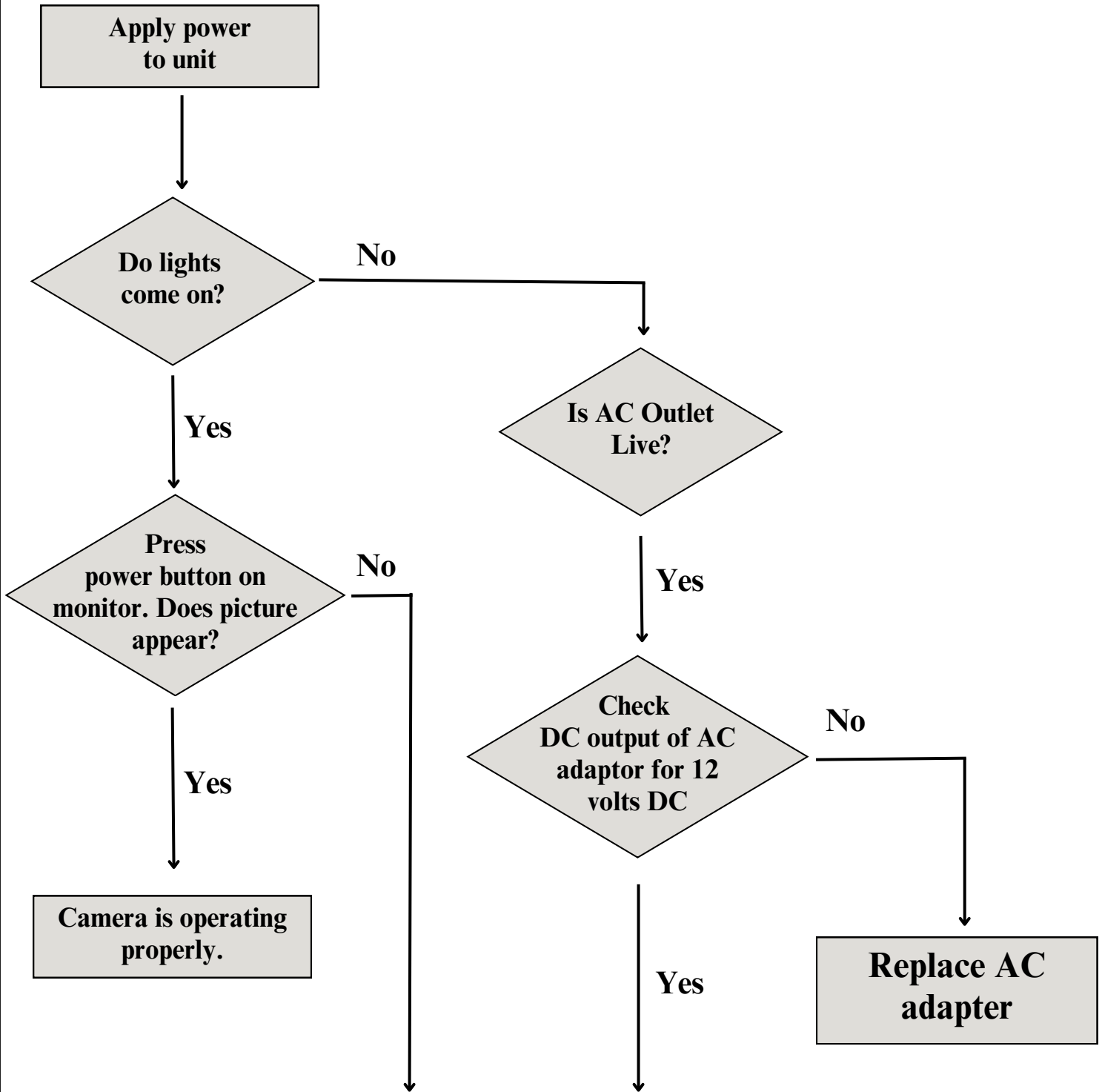

**Contact Service Department at 1-905-604-7040  
or [info@hathorncorp.com](mailto:info@hathorncorp.com)**

If a problem not shown on this chart is found, please contact a Hathorn service center.

## **MAINTENANCE**

**Inspection Camera** - After every use, the camera should be cleaned and checked for possible damage. External scuffing of the camera case is normal and should be of no concern. The camera view port is made of sapphire and should be cleaned with a soft, damp cloth. Grease, dirt, or scratches will affect the quality of the video, and if the lens is badly scratched, it should be replaced.

**LED Light Replacement** - The camera heads use LED lighting and cannot be replaced by the operator. These lights use very little power and, unless physically damaged or extreme voltage is applied to them, should last indefinitely. If replacement is necessary, the camera should be returned to the factory.

**Reel and Cable Assembly Maintenance** - The reel and cable assembly should be kept clean from dirt, slime, grit, etc. When winding the cable back onto the reel after an inspection, it is good practice to use a cloth to wipe off any debris. Hathorn also recommends the use of genuine Hathorn reel covers. Hathorn manufactures its reel covers from industrial-grade reinforced vinyl which will stop liquids from dripping on to your equipment.

### **WARNING**

**NEVER USE A POWER WASHER TO CLEAN YOUR INSPECTION EQUIPMENT. PRESSURIZED WATER MAY GET INTO UNSEALED AREAS SUCH AS THE USB BLOCK, REEL HUB ASSEMBLY, AND SLIP RING HOUSING, CAUSING DAMAGE.**

**WATER DAMAGE TO ELECTRONIC EQUIPMENT IS NOT COVERED BY YOUR WARRANTY.**

## **REPAIR FACILITIES - USA**

Repairs, warranty or otherwise, returned to must be submitted with a “**Return Maintenance Authorization.**” For “**RMAs**” please go to the Hathorn website and click on the blue button called “**Submit an RMA**”

### **Hathorn USA**

**Address:** 250 Lowery Court - Unit 2B Groveport, OH, 43125

**Phone:** 1-855-863-9226 **FAX:** 1-905-604-3400

**Email:** [usaservice@hathorncorp.com](mailto:usaservice@hathorncorp.com)

**Website:** [www.hathorncorp.com](http://www.hathorncorp.com)

### **Kaiser Premier USA – Mobile Repairs South West**

**Address:** 6108 Wild Fox Court, Elk Grove, CA 95757

**Phone:** 1-916-995-2743

**Email:** [eric.montgomery@kaiserpremier.com](mailto:eric.montgomery@kaiserpremier.com)

**Website:** [www.kaiserpremier.com](http://www.kaiserpremier.com)

### **Utility Equipment Technology Ltd**

**Address:** 382 Stevens Rd., Rockwall, TX 75032

**Phone:** 1-972-771-8958 **FAX:** 1-972-772-8195

**Email:** [utilityequipment@gmail.com](mailto:utilityequipment@gmail.com)

**Website:** [utilityequipmenttechnology.com](http://utilityequipmenttechnology.com)

### **Minicam**

**Address:** 12600 Newburgh Rd, Livonia, MI 48150

**Phone:** 1-855-863-9226 **FAX:** 1-905-604-3400

**Email:** [info@minicaminc.com](mailto:info@minicaminc.com)

**Website:** [www.minicaminc.com](http://www.minicaminc.com)

**Note: For other repair center locations please visit [www.hathorncorp.com/find-a-repair-center](http://www.hathorncorp.com/find-a-repair-center).**

## **REPAIR FACILITIES - CANADA**

Repairs, warranty or otherwise, returned to must be submitted with a “**Return Maintenance Authorization.**” For “**RMA**s” please go to the Hathorn website and click on the blue button called “**Submit an RMA**”

### **Hathorn Canada - Ontario, Manitoba & Eastern Canada**

**Address:** 480 Hood Road, Unit 5 Markham, ONL3R 9Z3

**Phone:** 1-905-604-7040 **FAX:** 1-905-604-3400

**Email:** [service@hathorncorp.com](mailto:service@hathorncorp.com)

**Website:** [www.hathorncorp.com](http://www.hathorncorp.com)

### **Pipescope Solutions**

**Address:** 1439 Youville Drive, Ottawa, ON K1C 4M8

**Phone:** 1-647-991-6735

**Email:** [pipescopeolutions@gmail.com](mailto:pipescopeolutions@gmail.com)

### **Access Spec Telecommunications - Quebec**

**Address:** 328 Rue St Paul, Repentigny, QC J5Z 4H9

**Phone:** 1-450-581-7009

**Email:** [service@accessspec.com](mailto:service@accessspec.com)

**Website:** [www.accessspec.com](http://www.accessspec.com)

### **The Drain Camera Shop – British Columbia**

**Address:** Unit 148 11782 River Road, Richmond, BC V6X 1Z7

**Phone:** 1-250-514-5976

**Email:** [info@thedraincamerashop.com](mailto:info@thedraincamerashop.com)

**Website:** [www.thedraincamerashop.com](http://www.thedraincamerashop.com)

### **FixedRight – Alberta and Saskatchewan**

**Address:** 8812-185 St. NW, Edmonton, ALB T5T 1W5

**Phone:** 1-780-690-9080

**Email:** [roger@fixedright.ca](mailto:roger@fixedright.ca)

**Website:** [www.fixedright.ca](http://www.fixedright.ca)

Note: For other repair center locations please visit [www.hathorncorp.com/find-a-repair-center](http://www.hathorncorp.com/find-a-repair-center).



# ***HATHORN***

---

## ***INSPECTION CAMERAS***

### **Hathorn Canada**

**480 Hood Road, Unit 5  
Markham, ON  
L3R 9Z3 Canada**

**+1 (866) HATHORN**

### **Hathorn USA**

**250 Lowery Court, Unit 2B  
Groveport, OH  
43125 USA**